



## ► Safe packaging automation: food, pharmaceuticals, non-food

**PILZ**  
THE SPIRIT OF SAFETY

Flexible automation solutions for Safety and Security.

Let's WRAP this up together!

- Product safety and Packaging 4.0
- Sensors, control technology and services



## ► Safe automation solutions for the packaging of food,

With the increasing significance of flexible packaging processes, sustainable packaging materials and digital data, intelligent Safety and Security components are vital in automation solutions to ensure the overall equipment effectiveness, safety and flexibility of your packaging machinery.

We support you as the manufacturer and operator of packaging machines in the implementation of your safe packaging automation in primary, secondary and end-of-line packaging. Choose automation solutions for Safety and Security. Thanks to our many years of industry experience, we support you with our services: from risk assessment to CE certification and through to complete engineering.



Visit our website for more information:



Webcode:  
web0749

Online information at [www.pilz.com](http://www.pilz.com)

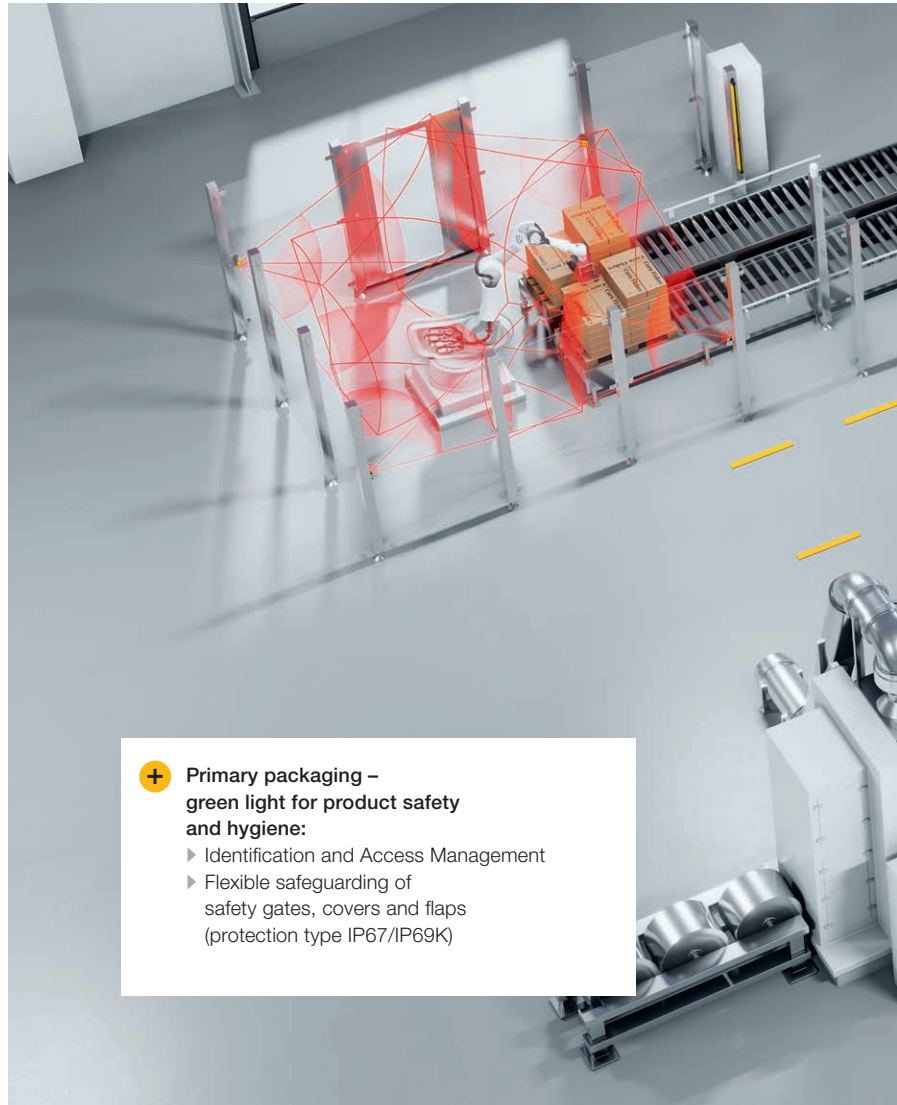

**+ Primary packaging – green light for product safety and hygiene:**

- Identification and Access Management
- Flexible safeguarding of safety gates, covers and flaps (protection type IP67/IP69K)

### Benefits to you:

- Flexible solutions for Safety and Security
- Expertise relating to international standards and directives
- Risk analysis and safety concept for all your machinery
- Individual consulting for needs-oriented solutions
- Flexibility thanks to open interfaces
- Saves time and costs thanks to simple software tools

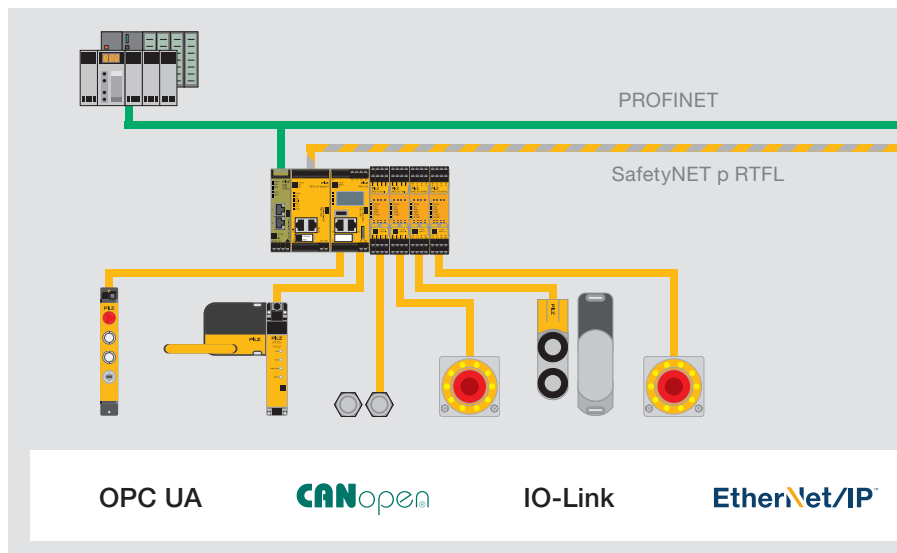



# pharmaceuticals and non-food

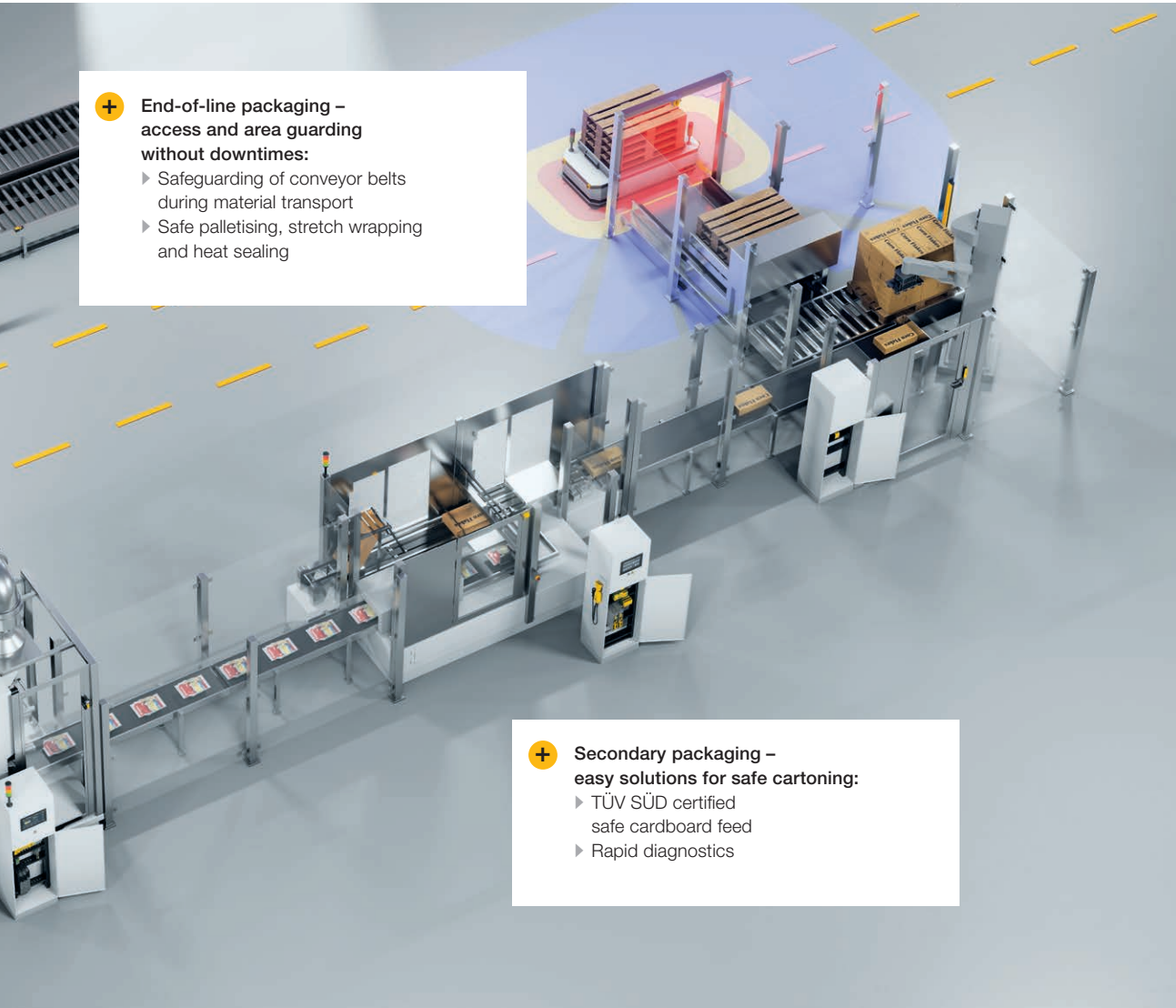

**+ End-of-line packaging – access and area guarding without downtimes:**

- ▶ Safeguarding of conveyor belts during material transport
- ▶ Safe palletising, stretch wrapping and heat sealing

**+ Secondary packaging – easy solutions for safe cartoning:**

- ▶ TÜV SÜD certified safe cardboard feed
- ▶ Rapid diagnostics

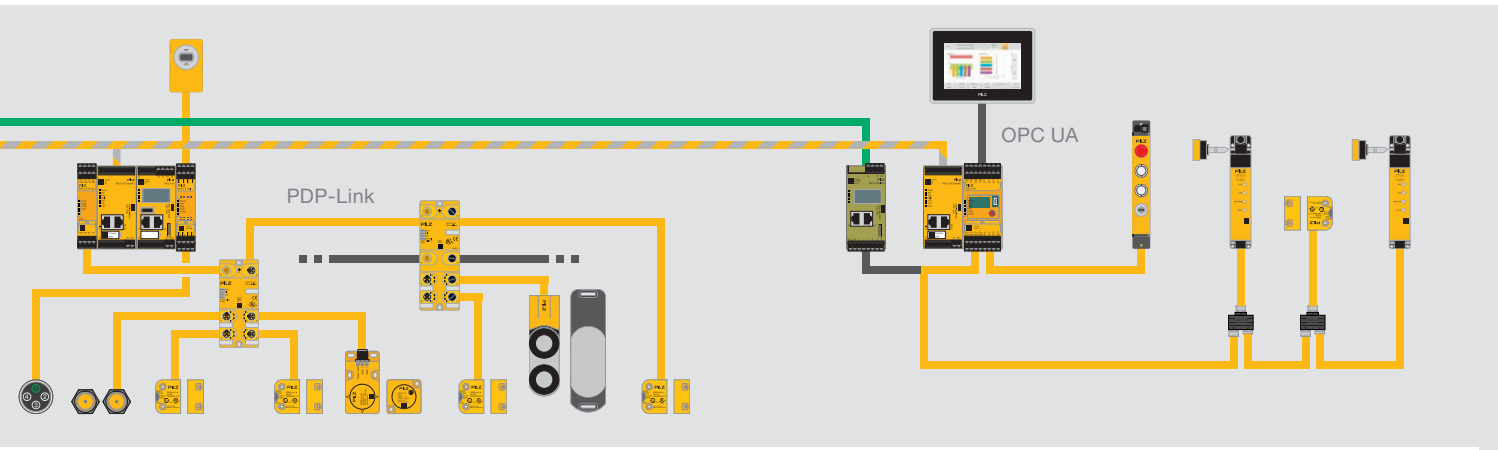

- EtherCAT
- Modbus
- PROFIBUS
- PROFINET
- ETHERNET POWERLINK

## ► Safety and hygiene for your product



### Product safety with Identification and Access Management – I.A.M.

To ensure operation with as few failures as possible, access and user rights at specific sections of the plant should be clearly and explicitly regulated. The modular access permission system covers both Safety and Security requirements, allowing it to offer employee, liability and data protection at those locations where regular access is regulated and it is necessary to switch back and forth between operating modes.

### Maintenance safeguarding system “key-in-pocket”

The “key-in-pocket” solution prevents the unplanned restart of machinery. Authentication of the operators is performed with their personal transponder keys. The security IDs of the users are stored in a safe list in a controller such as the PNOZmulti 2 or PSS 4000. It is only possible to restart the plant if there are no longer any people in the danger zone and all users are signed out.



Visit our website for more information:



Webcode:  
web0749

### Safe operating mode selection

With the safe operating mode selection and access permission system PITmode you can make sure that the respective operating modes of the plant can only be executed by personnel qualified for this. This helps you protect your staff from danger and your machinery from unauthorised access.

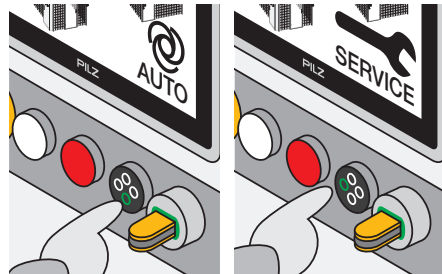

Online information at [www.pilz.com](http://www.pilz.com)

### Safe sensors made of stainless steel

Gates, covers or flaps on packaging machinery can be safely monitored magnetically, mechanically or electronically. To meet the specific requirements for cleanliness and sterility, the access management I.A.M. with the safety gate system PSENmlock and a magnetic safety switch made of stainless steel, such as the PSENmag stainless steel version with protection class IP67/IP69K, is installed on plants.



Access management I.A.M. with PSENmlock and magnetic safety switch PSENmag stainless steel version.

## ► Safe cardboard feed and networking

### TÜV SÜD certified safe monitoring of the cardboard feed

Intelligent safety solutions minimise the possibility of access to a danger zone. The optical detection of the cardboard boxes in the tray formers prevents an operator from reaching through an empty material infeed opening into the machine. The Pilz solution comprises the safe small controller PNOZmulti 2 – or the modular safety relay myPNOZ – as well as two photoelectric sensors. If the number of cardboard boxes in the magazine falls below the defined minimum, this will be detected by two photoelectric sensors, which shut down the outputs via the safe small controller or the modular safety relay. The machine remains in stop mode until packaging is again in place. This safety solution is TÜV SÜD certified and can be easily retrofitted, even on older tray formers.

### High plant availability thanks to fast diagnostics

Intelligent, networked processes can significantly increase the productivity of the packaging machine. However, this is only possible if a wide variety of data is automatically available. Pilz Safety Device Diagnostics offers a solution with which diagnostic data such as individual serial numbers, version status, current states and error states can be recorded.

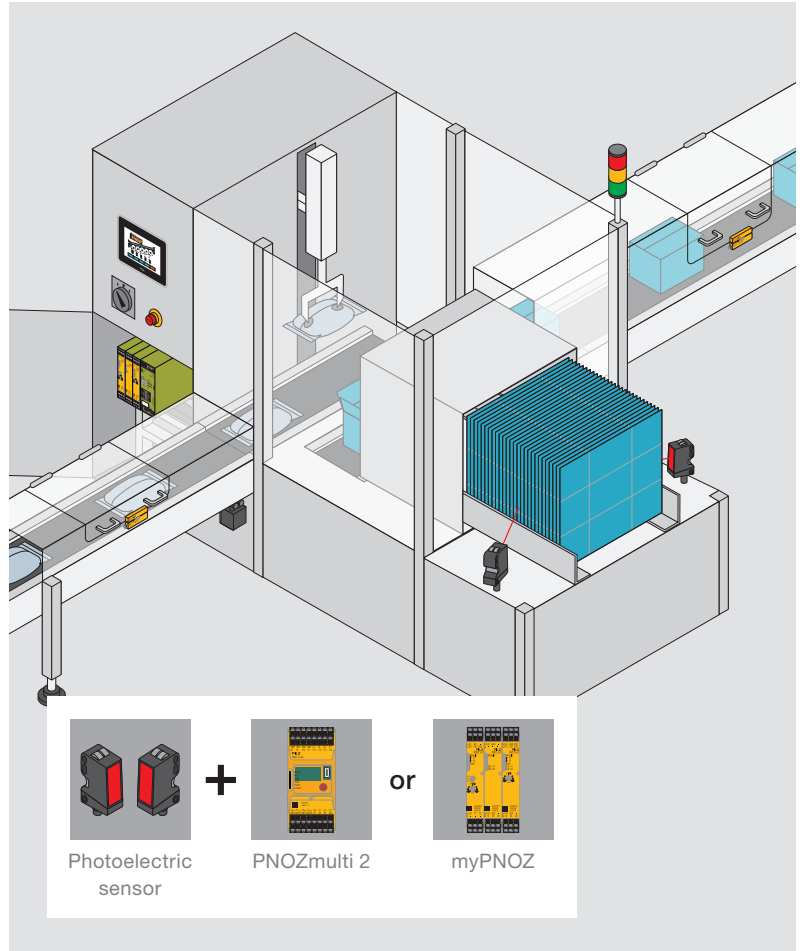

Solution for safe cardboard feed up to PL d/SIL 2 as well as fast diagnostics with SDD and coded safety switches PSENcode.

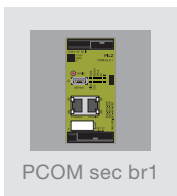

### Data and network security

The networking of IT and OT (operational technology) means that additional protection against external attacks is required for your machinery. With the firewall SecurityBridge you protect the control network against manipulation through unauthorised access.



### Packaging 4.0

Every solution requires individual interfaces and high flexibility in order to satisfy modular packaging processes in regards to 4.0. We offer this flexibility in our automation and safety solutions. You can combine the safe sensor technology from Pilz with any safety relays, small controllers and control systems as desired.

## ► Access and area guarding

For access and area guarding in end-of-line packaging, various safety solutions can be used to optimise plant availability with maximum protection for the operators.

### Access management at safety gates

Modular safety gate systems are suitable for safe interlocking and guard locking of safety gates. Depending on the requirement, various sensors can be combined with safe process guard locking PSENSlock or safe guard locking PSENmlock for personnel protection. The door handle module DHM can be supplemented with integrated actuator, escape release and, if necessary, authentication.

### Non-contact safeguarding of conveyor belts

Safety light curtains PSENopt II protect against access to hazardous machine areas and detect both static and dynamic obstacles. Muting, blanking and cascading functions are used here. Depending on the requirement, the safety light curtains provide finger, hand and body protection and are designed for applications up to PL d or PL e to EN IEC 61496.

### Safe stretch wrapping and heat sealing of pallets

Safe monitoring of a stretch wrapping machine for the operator requires handling high temperatures and protection against encroachment from behind. The combination of the safe radar system PSENradar and the configurable small controller PNOZmulti 2 is ideal for this. This combination is suitable for applications up to PL d/Cat. 3 in accordance with EN ISO 13849-1.

IP67 modules with zinc housing can be used as the connection element for several sensors for control. They guarantee data transfer at -30 °C to 70 °C.

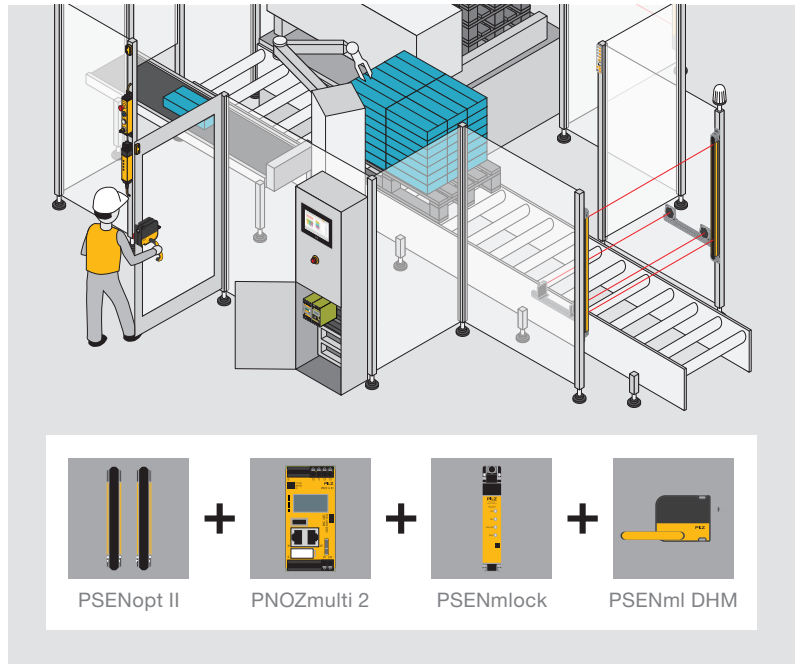

Safe material transport with safety light curtains PSENopt II with integrated muting arms as well as modular safety gate system PSENmlock with door handle module DHM.

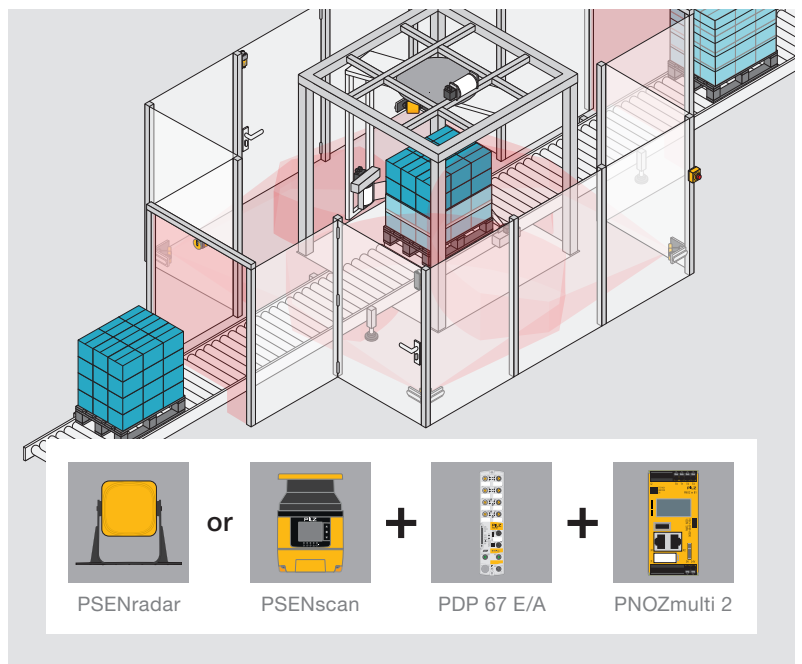

Stretch wrapping of the pallet with safe radar system PSENradar and PNOZmulti 2 as well as efficient conveying with safety laser scanners PSENscan.

# ► Services: Consulting, engineering and training

As a solution supplier, Pilz can help you in the global application of optimum safety strategies that comply with specifications. Our services ensure the highest safety for man and machine worldwide.



### Machinery safety

Safety through the whole machine lifecycle

- ▶ Risk Assessment
- ▶ Safety Concept
- ▶ Safety Design
- ▶ System Implementation
- ▶ Safety Validation

**Safe machinery at any stage**



### International Compliance and Acceptance

Conformity with international standards and regulations

- ▶ CE Marking
- ▶ USA
- ▶ NR-12
- ▶ UKCA Marking
- ▶ Machinery Compliance and Acceptance
  - Design Risk Assessment DRA
  - Factory Acceptance Test FAT
  - Site Acceptance Test SAT

**Compliant machines worldwide**



### Workplace safety

Absolute safety when operating machines

- ▶ Machinery Safety Evaluation
- ▶ Lockout Tagout System
- ▶ Inspection of Safeguarding Devices

**The maximum possible safety for man and machine**



### Training

International qualification programme and certified courses

**Enhancement of professional development**



Pilz GmbH & Co. KG, Ostfildern, operates an inspection body for plant and machinery, accredited by DAkKS.



**Machinery safety**  
We offer you comprehensive safety services customised to your company's needs throughout the entire machine lifecycle.



**Training**  
Pilz supports you with a comprehensive range of training courses on all topics of machinery safety and automation.



**International Compliance and Acceptance**  
We can assist you throughout the conformity assessment of your plant and machinery on all continents. In us, you have a local contact who will coordinate your project both locally and internationally.



**Workplace safety**  
Because the safety of your employees is your highest priority, we support you with a comprehensive range of services for standard-compliant analysis and optimisation of your safety status in the workplace.

Keep up-to-date on Services



Training



Online information at [www.pilz.com](http://www.pilz.com)

# Support

Technical support is available from Pilz round the clock.

## Americas

### Brazil

+55 11 97569-2804

### Canada

+1 888 315 7459

### Mexico

+52 55 5572 1300

### USA (toll-free)

+1 877-PILZUSA (745-9872)

## Asia

### China

+86 400-088-3566

### Japan

+81 45 471-2281

### South Korea

+82 31 778 3300

## Australia and Oceania

### Australia

+61 3 95600621

### New Zealand

+64 9 6345350

## Europe

### Austria

+43 1 7986263-444

### Belgium, Luxembourg

+32 9 3217570

### France

+33 3 88104003

### Germany

+49 711 3409-444

### Ireland

+353 21 4804983

### Italy, Malta

+39 0362 1826711

## Scandinavia

+45 74436332

## Spain

+34 938497433

## Switzerland

+41 62 88979-32

## The Netherlands

+31 347 320477

## Turkey

+90 216 5775552

## United Kingdom

+44 1536 462203

## You can reach our international hotline on:

+49 711 3409-222

support@pilz.com

Pilz develops environmentally-friendly products using ecological materials and energy-saving technologies. Offices and production facilities are ecologically designed, environmentally-aware and energy-saving. So Pilz offers sustainability, plus the security of using energy-efficient products and environmentally-friendly solutions.



Presented by:

Pilz GmbH & Co. KG  
Felix-Wankel-Straße 2  
73760 Ostfildern, Germany  
Tel.: +49 711 3409-0, Fax: +49 711 3409-133  
E-Mail: info@pilz.com, Internet: www.pilz.com

We are represented internationally. Please refer to our homepage [www.pilz.com](http://www.pilz.com) for further details or contact our headquarters.

Headquarters: Pilz GmbH & Co. KG, Felix-Wankel-Straße 2, 73760 Ostfildern, Germany  
Telephone: +49 711 3409-0, Telefax: +49 711 3409-133, E-Mail: info@pilz.com, Internet: www.pilz.com

Printed on 100 % recycled paper for the good of the environment.

**PILZ**  
THE SPIRIT OF SAFETY